



**95155B/9526B**

**Multiplicadores de torque  
manuales con brazos de reacción  
rectos de 4500 Nm**



**DETALLES DEL PRODUCTO**

- Sistema de bloqueo de crique disponible en todos los multiplicadores
- Transportador de ángulo para un torque fácil y un ajuste de ángulo
- La gama cubre un torque de salida máx. de hasta 4500 N.m
- Siempre utilice con llave dinamométrica (sentido horario y antihorario) para evitar exceder el torque máximo de los multiplicadores
- Precisión  $\pm 4$
- El sistema de bloqueo de crique contiene las fuerzas generadas durante el apriete
- Permite hacer lo que de otra forma sería difícil, peligroso o incluso imposible
- Se suministra con barra de reacción recta
- Relaciones de torque verdaderas 15.5:1 (3000 N.m) o de multiplicación 26:1 (4500 N.m) permiten el uso de llave de torque pequeña
- Se suministra en caja plástica portátil forrada de espuma
- Hecha en Reino Unido

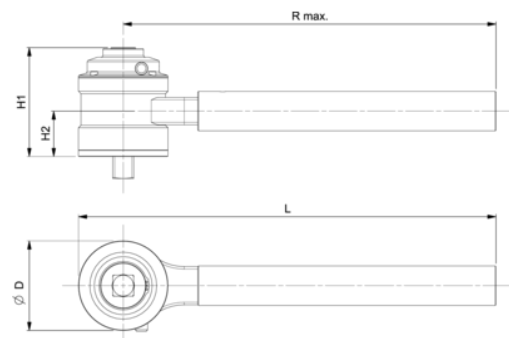









**Follow the Fish!**











ATRIBUTOS DE PRODUCTO

**Producto: 95155B-3000**

 3000 N·m	 1/2 in	 15.5:1
 193 N·m	 1 in	 108 mm
H1 mm 131 mm	H2 mm 55 mm	 504 mm
R max mm 450 mm	 1.9 kg	 6.1 kg

**Producto: 9526B-4500**

 4500 N·m	 1/2 in	 27:1
 166 N·m	 1 in	 108 mm
H1 mm 149 mm	H2 mm 55 mm	 504 mm
R max mm 450 mm	 1.9 kg	 6.1 kg

